

PF-Underseat-12.8V 100Ah Heating

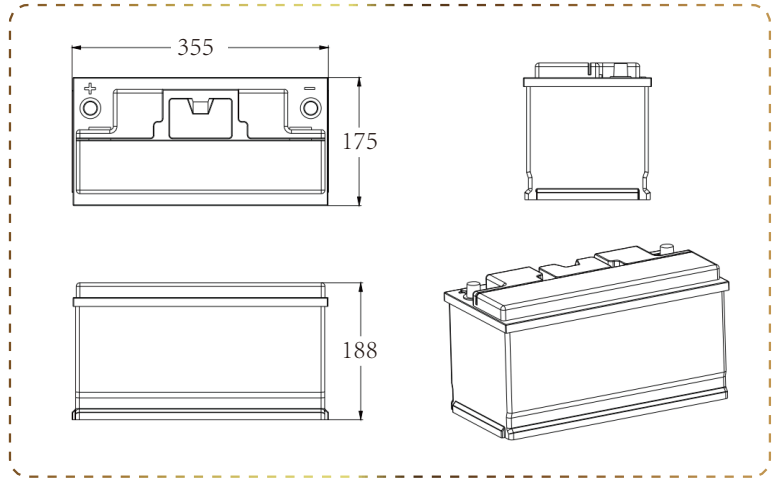

LITHIUM BATTERY

Strong Advantages

- 6 Years Warranty
- Directly eliminate lead-acid battery
- Lighter weight and easier to handle
- Lithium iron phosphate is more stable
- Maximum service life of over 6000 cycles
- Long-lasting modular construction
- Screw opening, perfect crafted internal structure design
- Electric heating film patented technology

ELECTRIC HEATING FILM

Patented Technology

- All the Perfektium lithium batteries with heating module, up to -35 degrees
- The heating film is an IP material and the heating is even
- BMS has a heating control function, to ensure that the battery itself is not consumed

BMS

Battery Management System

The BMS monitors and controls the individual cells of a battery and protects them from damage, such as overload and overvoltage

BLUETOOTH 4.0 INTEGRATED

Multiple Battery Monitoring Function

Perfektium Pro APP can monitor up to 8 batteries at the same time now. The SOC, voltage, current, temperature, available time of the battery set can be detective.



Specification

Items	Characteristics
Model	12.8V 100Ah/ 1280Wh
Dimension (L x W x H)	355×175×188mm
Weight (No Accessories)	12.6kg
Cycle Life	>6000@80%D.o.D
Internal Resistance	≤15 mΩ @ 50% SOC
Recommended Charge Voltage	14.6V
Float Charge Voltage(For standby use)	13.8±0.8V
Recommended Charge Current	30A
Max Charge Current	50A
Continuous Discharge Current	150A
Peak Discharge Cut-Off Current	450A (200~500ms)
Operating Voltage Range	10 - 14.6V
End of Discharge Voltage Range	9.2 - 11.2V
Terminal Type	M8
Ingress Protection Code	IP65
Charge Temperature	0~50°C
Discharge Temperature	-20~75°C
Storage Temperature	-5~35°C
Heater Operating Temperature	-35~5°C
Storage Condition	Charging the battery every 3 months
Series & Parallel Availability	4 Series and 4 Parallel at most
Certifications	CE/UL/UN38.3/MSDS/ROHS/UN 3480/CLASS 9